



RODAN(TAIWAN)LTD.

HIGH POWER

審查	作成
沈夢榮	沈子檸

1.ELEMENT APPEARANCE

PAGE : 1 / 6

Model No.	Lighting Color	Lens Color
RT-M3535VT10L-PL	UV	Water Clear

2.ABSOLUTE MAXIMUM RATINGS AT Ta=25°C

Characteristic	Symbol	Rating	Unit
Forward direct current	IFM	450	mA
Reverse voltage	VRM	5	V
Operating temperature	Topr	-40 to +105	°C
Storage temperature	Tstg	-40 to +120	°C
Power dissipation	Pd	1	W

3.ELECTRO-OPTICAL CHARACTERISTICS AT Ta=25°C

Characteristic	Symbol	Condition	Min.	Typ.	Max.	Unit
Radiant intensity	Ie	IF=350mA		530		mW/sr
Forward voltage	VF	IF=350mA		3.4	4.1	V
Reverse current	IR	VR=5V			10	μA
Peak emission wavelength	λp	IF=350mA	390	400	410	nm
Spectral band width @ 50%	Δλ	IF=350mA		15		nm
Viewing angle	2θ 1/2	IF=350mA		120		deg.

※ Radiant Intensity Measurement allowance is ±15%

※ Forward voltage Measurement allowance is ±0.1V

※ Peak emission wavelength Measurement allowance is ±1nm

4.BIN

Ie (mW/sr) IF=350mA		
Rank	MIN	MAX
Q	435	515
R	515	635
S	635	755

※ Power 誤差值±15%

VF (V) IF=350mA		
Rank	MIN	MAX
A	2.85	3.10
B	3.10	3.35
D	3.35	3.60
E	3.60	3.85
F	3.85	4.10

※VF 誤差值±0.1 V

λp (nm) IF=350mA		
Rank	MIN	MAX
1	390	395
2	395	400
3	400	405
4	405	410

※波長誤差值±1.0 nm



RODAN(TAIWAN)LTD.

Model : RT-M3535VT10L-PL

PAGE : 2 / 6

5.DIMENSIONS UNIT : m/m

Tolerance is $\pm 0.25\text{mm}$ unless otherwise specified.

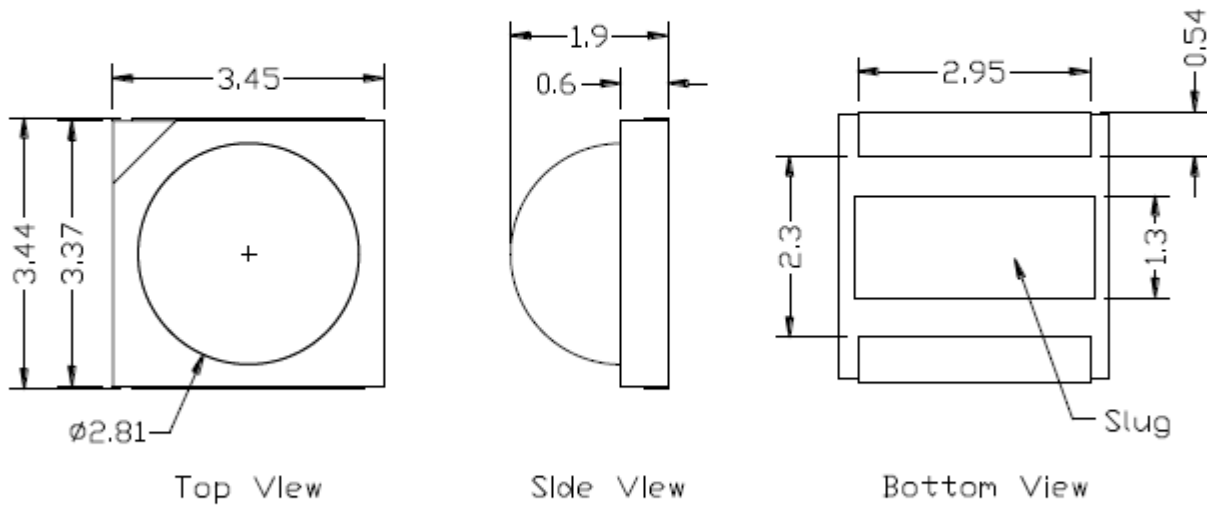
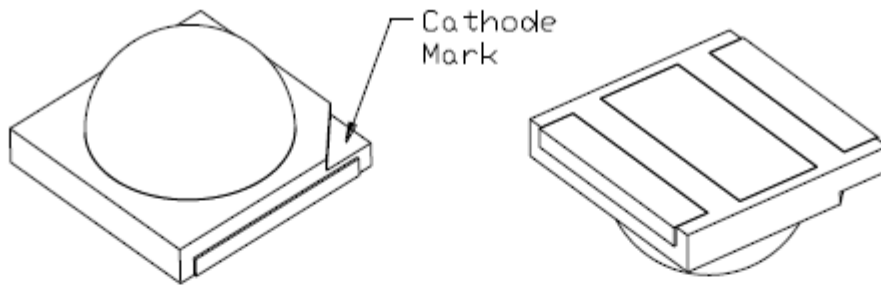

Circuit Diagram

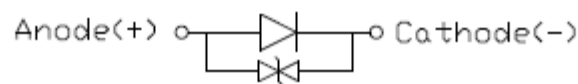



Model : RT-M3535VT10L-PL

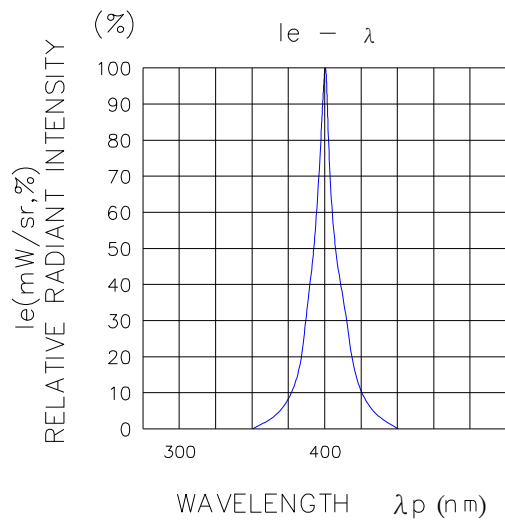
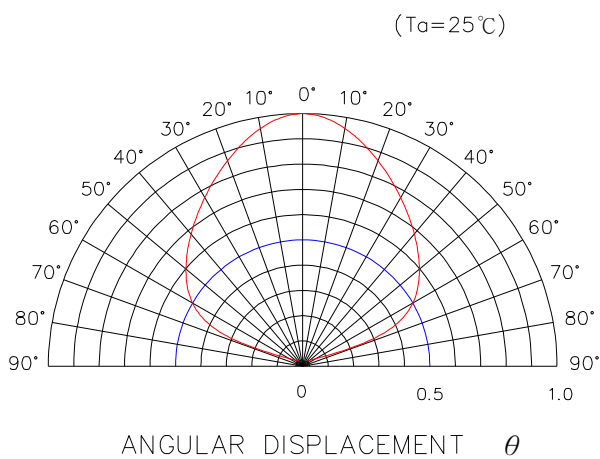
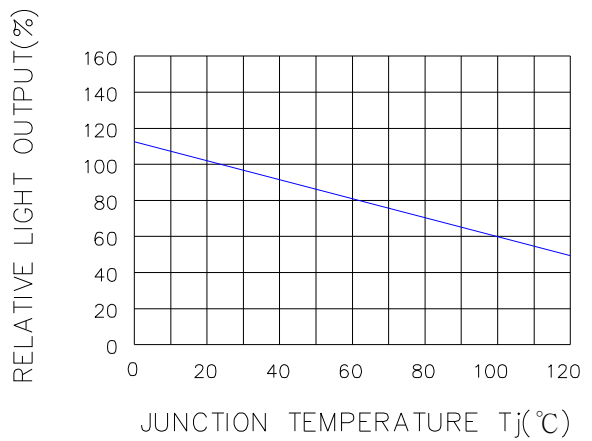
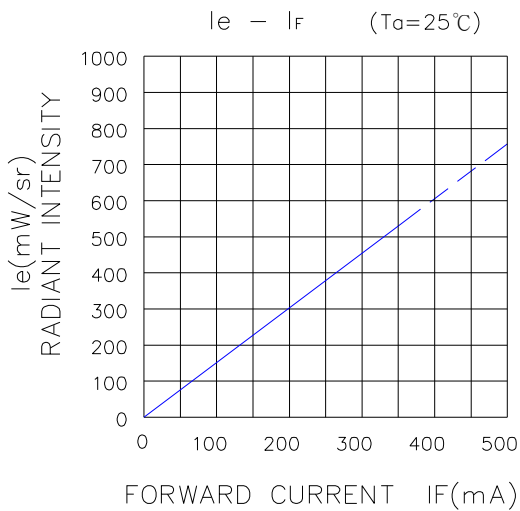
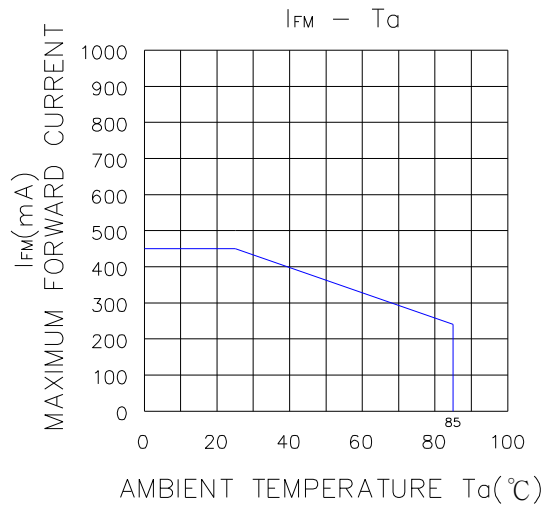
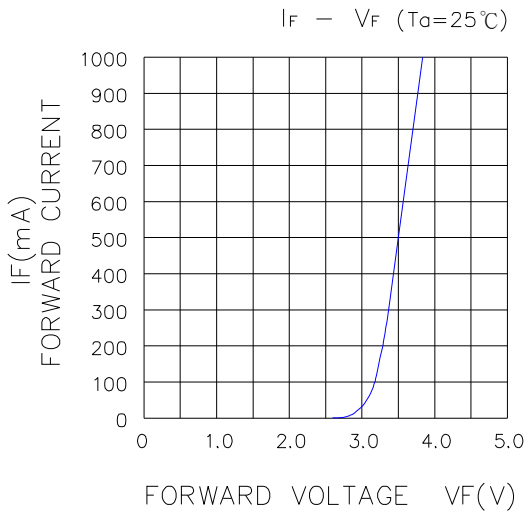



Recommended Solder Pad Design

Standard Emitter

TYPE A.

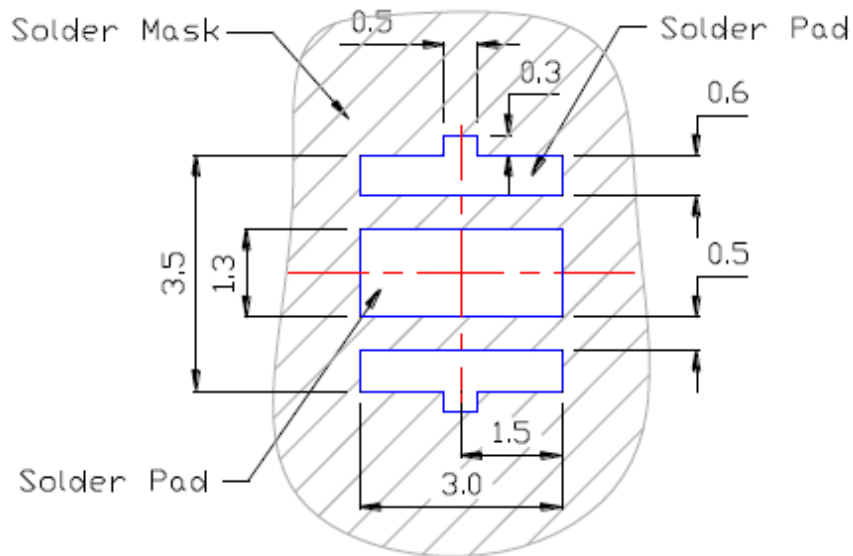

TYPE B.

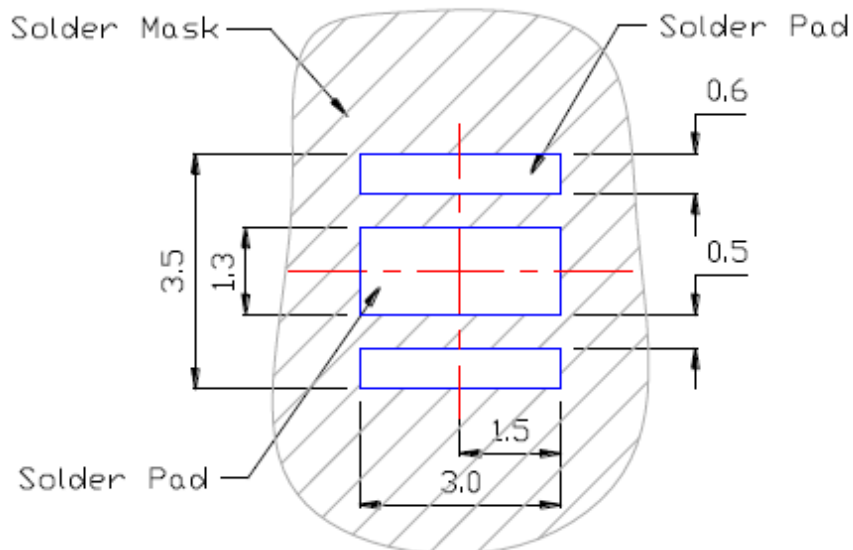



Emitter Reel Packaging

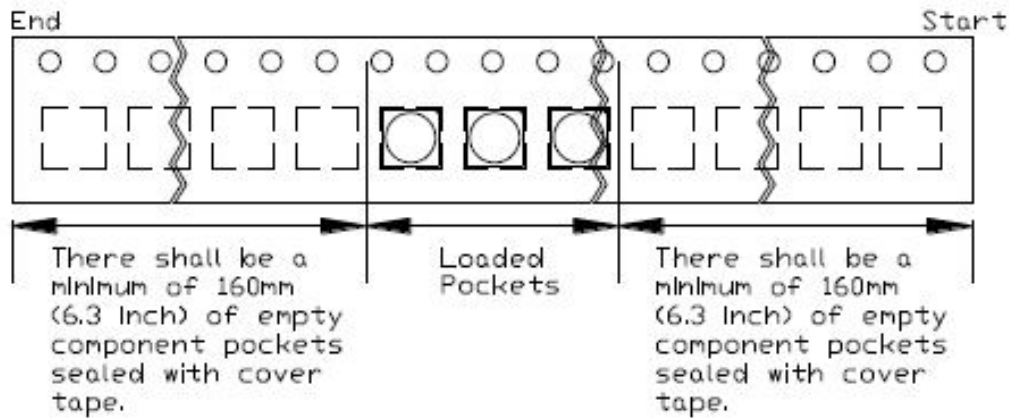
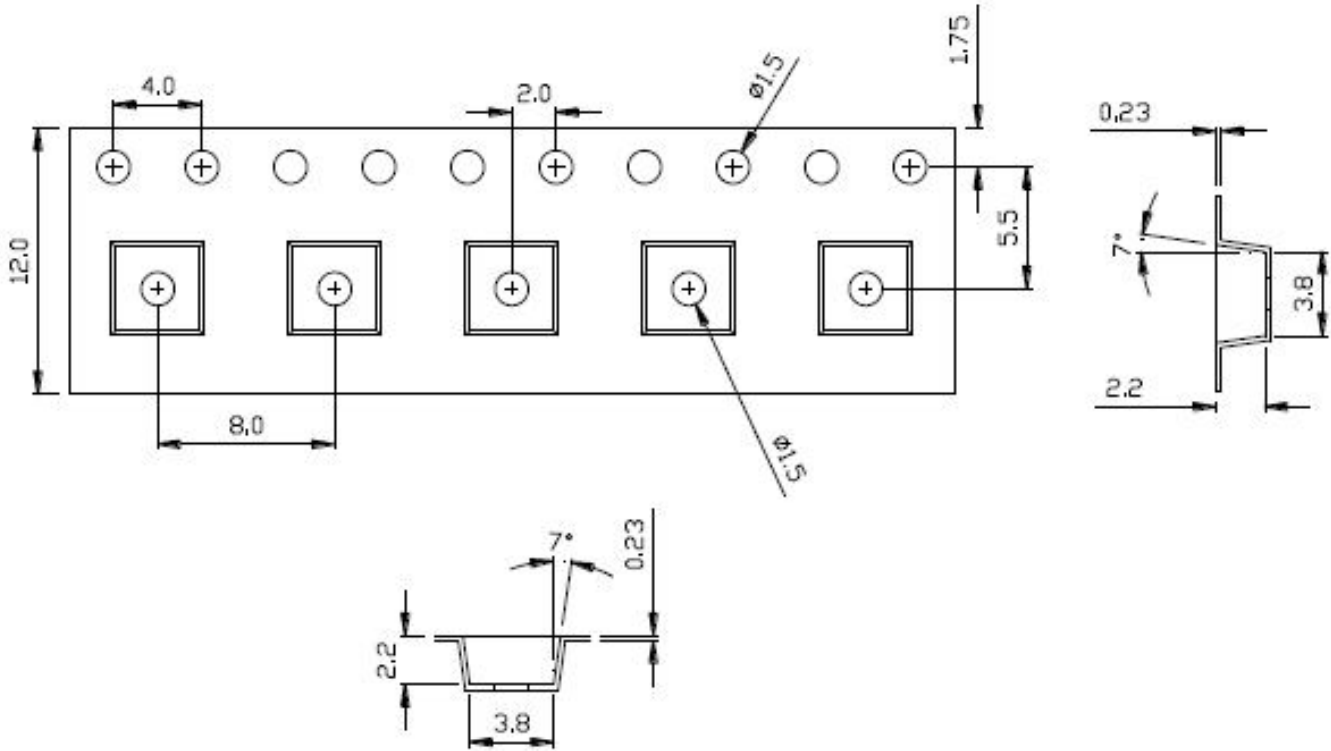

Notes:

1. Drawing not to scale.
2. All dimensions are in millimeters.
3. Unless otherwise indicated, tolerances are ± 0.10 mm.



Emitter Reel Packaging

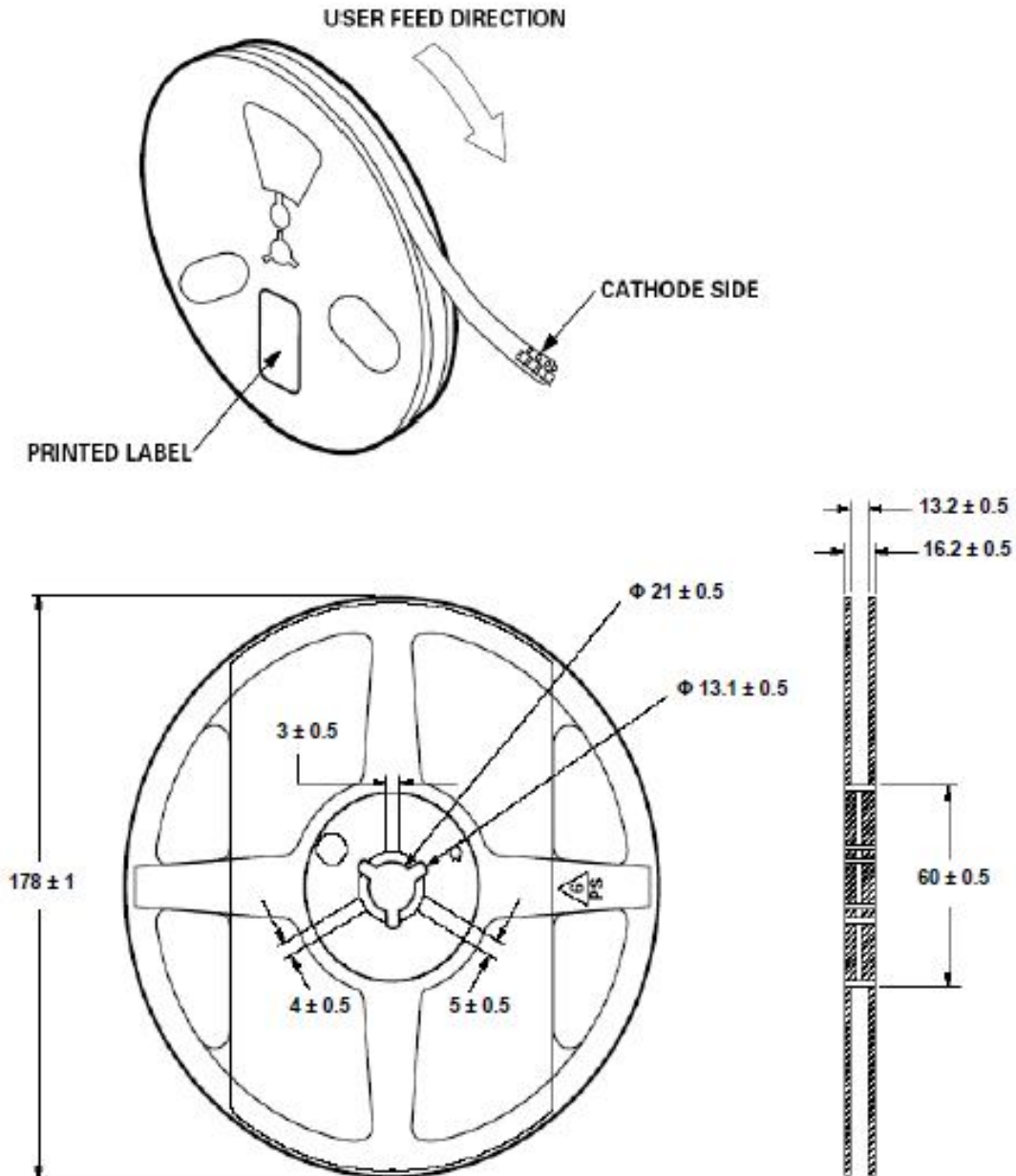

Notes:

1. Empty component pockets sealed with top cover tape.
2. 250, 500 and 1000 pieces per reel.
3. Drawing not to scale.
4. All dimensions are in millimeters.